



G399



G400



G401



G402



G403



G404



G405



G406



G407



G408



G409



G410



G411



G412



G413



G414



G415



G416



G417



G418



G419



G420



G421



G422



G423





G424



G425



G426



G427



G428



G429



G430



G431



G432

G433



G434



G435



G436



G437



G438



G439









G540



G541

G542



G543



G544



G545

G546



G547



G548



G549



G550



G551



G552



G553



G554



G555



G556



G557



G558



G559

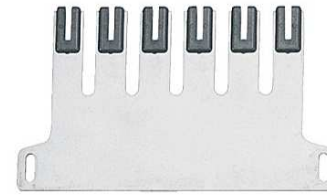

G562

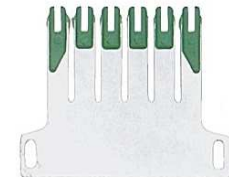

G563



G560



G561



G564



G565



G566



G567



G568



G569



G570

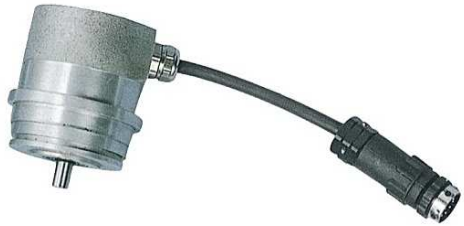

G571



G572



G573



G574



G575



G576



G577



G581



G582



G578



G583



G579



G584



G585



G580



G586



G587



G588



G589



G590



G591



G592



G593



G594



G595



G596



G597



G598



G599



G600



G601

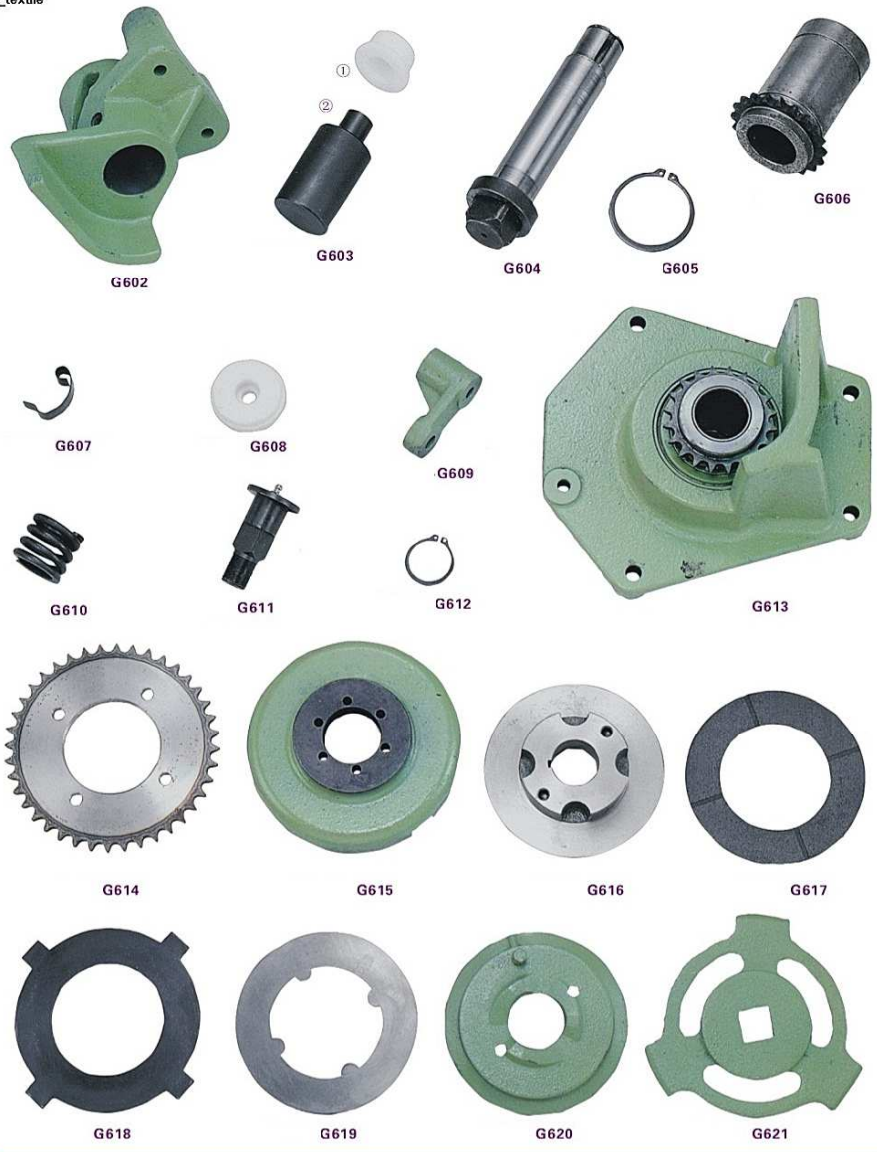





G676



G677



G678



G679



G680



G681



G682



G683



G684



G685



G686



G687



G688



G689



G690



G691



G692



G693



G694



G695



G696



G697



G698



G699

GRAPHITE



G700



G701

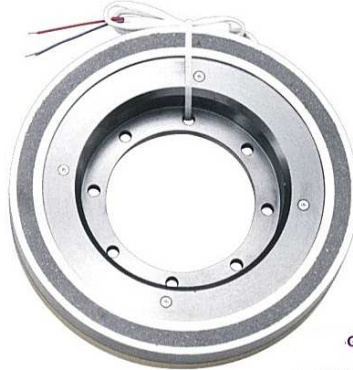

G702

GRAPHITE



G703



G704



G705

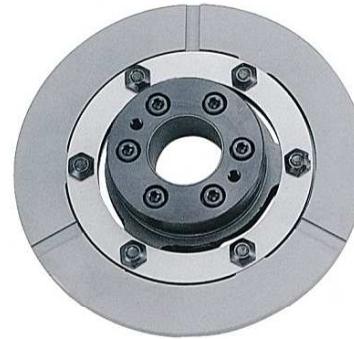

G707



G706

GRAPHITE



G708

GRAPHITE



G709

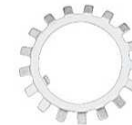

G710



G711



G712



G713



G714



G715



G716



G717



G718



G719



G720



G721



G722



G723



G724

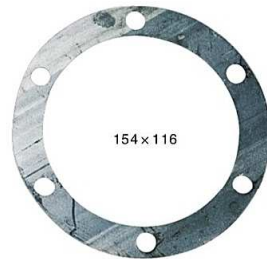

G725



G726



G727



G728



G729



G730



G731



G732



G733



G734



G735



G736



G737



G738



G740



G741



G739



G742



G743



G744





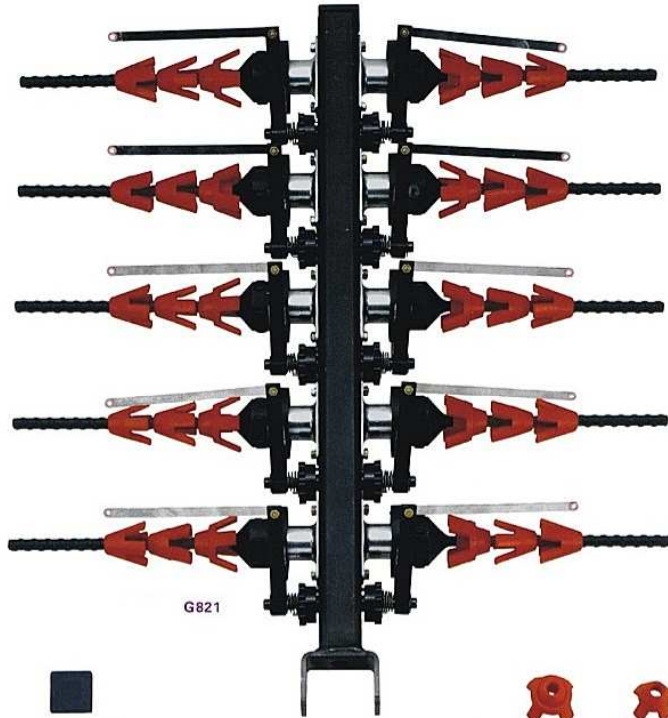

G821



G822



NCTM-G825



G828



G829



G832



G834



G826



G830



G823



G824



G827



G831



G833



G835

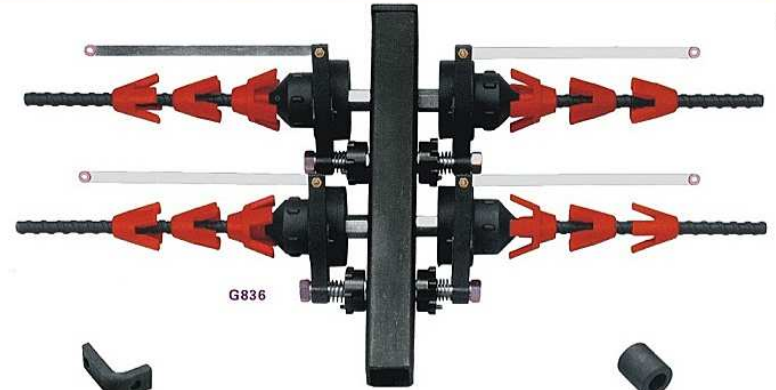

G836



G837



G838



G839



G840



G841



G842



G843



G844



G845



G846



G847



G848



G849



G850



G851



G852



G853



G854



G855



G856



G857



G858



G859



G860



G861



G862



G863



G864



G865

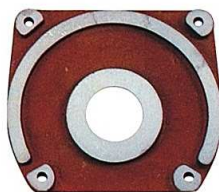

G866



G867



G868



G869



G871



G872



G870



G873



G874



G877



G878



G879



G875



G876



G880



G881



G882



G883



G885



TM-G886



G887



G888



G884



G889



G890

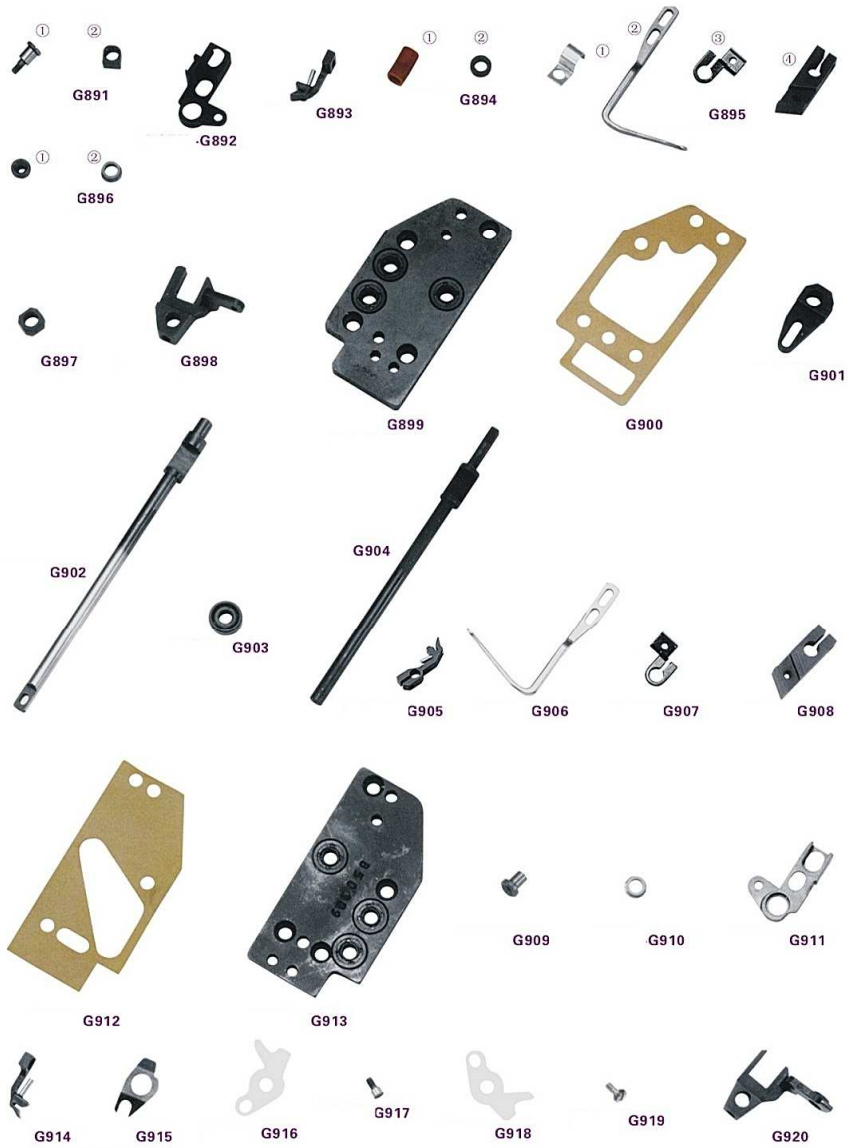



G947



G948



G949



G950



G951



G952



G953



G954



G955



G956



G957



G958



G959



G960



G961



G962



G963



G964



G965



G966



G967



G968



G969

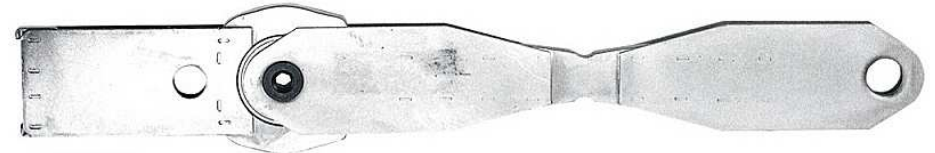

G970



G971

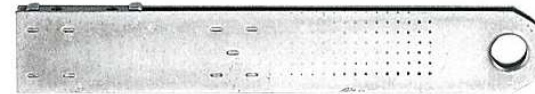

G972



G973



G974



G975



G976



G977



G978



G979



G980



G981



G982

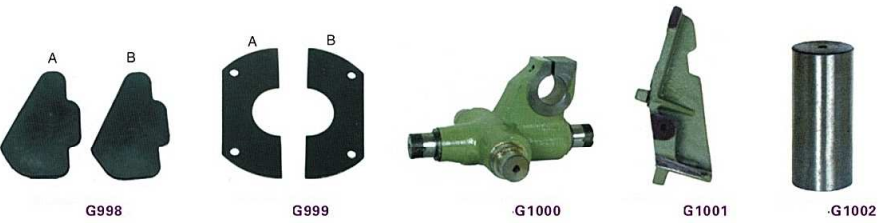





G1067



G1068



G1069



G1070



G1071



G1072



G1073



G1074



G1075



G1076



G1077



G1078



G1079



G1080



G1081



G1082



G1083



G1084



G1085



G1086



G1087



G1088



G1089



G1090



G1091



G1092



G1093



G1094



G1095



G1096



A

G1097



B



A



B

G1098



C



A

B

G1099



G1100



G1101



G1102

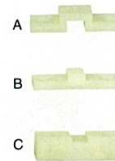

A

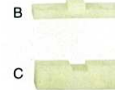

B



C

G1103



B

A

G1104



G1105



G1106



G1107



G1108

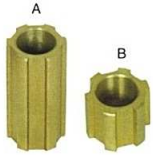

G1109



G1110



G1111



G1112



G1113



G1114



G1115

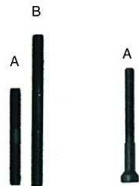

G1116



G1117



G1118



G1119



G1120



G1121



G1122

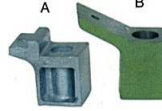

G1123



G1124



G1125



G1126



G1127



G1128



G1129



G1130



G1131



G1132



G1133



G1134



G1135



G1136



G1137



G1138



G1139

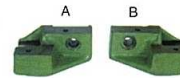

G1140



G1141



G1142



G1143



G1144



G1145



G1146



G1147



G1148



G1149 G1150 G1151 G1152 G1153 G1154



G1155 G1156 G1157 G1158 G1159 G1160

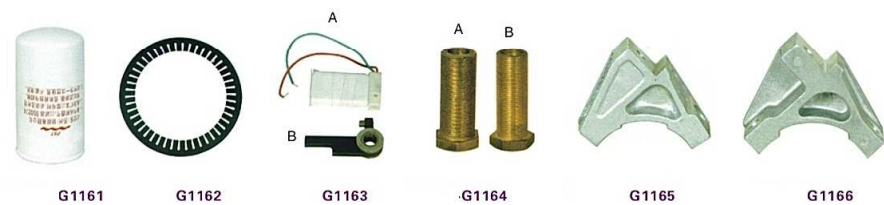

G1161 G1162 G1163 G1164 G1165 G1166



G1167 G1168 G1169 G1170 G1171



G1172 G1173 G1174 G1175 G1176



G1177 G1178 G1179 G1180 G1181



G1182 G1183 G1184 G1185



G1186 G1187 G1188



G1189
GTMAS.
B54052



G1190
GTMAS
B54051



G1191
GTMAS.



G1192
GTMAS



G1193
GTMAS
B53051



G1194
GTMAS



G1195
GTM
B83978



G1196
GTM
B87908



G1197
GTMAS



G1198
GTM



G1199
GTM
B83108



G1200
GTMAS
B83246



G1201
GTMAS
B54701



G1202
GTMAS
151980



G1203
GTMAS. (W=30mm)



G1204
GTM



G1205



G1206
GTM/AS



G1207
GTM/AS



G1208
GTM



G1209
GTMAS



G1210



G1211
GTM/AS



G1212
Φ800 Φ1000

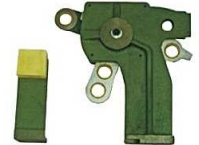

G1213
GTMAS



G1214
GTMAS



G1215



G1216
GTM/AS



G1217
GTM/AS

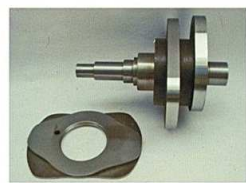

G1218
GTM/AS



G1219
GTM/AS



G1229

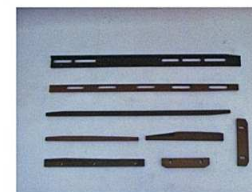

G1230
GTM/AS



G1231
GTM/AS (190, 220)



G1220
(L=532, 565, 585mm)
(H=25, 35, 45, 50mm)



G1221
φ 290.6mm



G1222

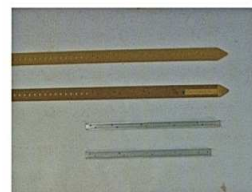

G1232



G1233
GTM/AS



G1234
GTMAS
GTM/AS/GAMMA



G1223



G1224
(δ=12, 18 mm)



G1225
GTM/AS
(φ 48*26)
(φ 48*29)
(φ 40*24)

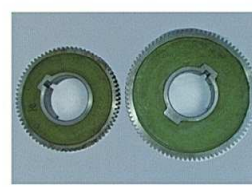

G1235
72 φ 800;
88 φ 1000;

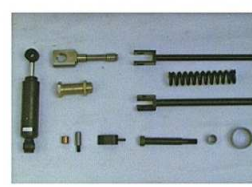

G1236
GTM/AS



G1237
GTM/AS



G1226
GTM/AS



G1227
GTM/AS
GTM/AS/

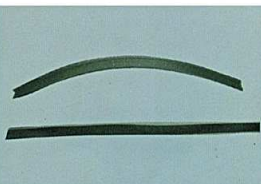

G1228
GTM/AS



G1238
GTM/AS



G1239
GTM



G1240
GTMAS



G1241

GTM



G1242



G1243

GTM/AS W=25, 28mm



G1253

GTM/AS



G1254



G1255



G1244

GTM (29T, 36T)



G1245

GTM/AS:



G1246



G1256

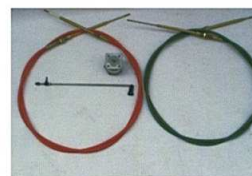

G1257



G1258

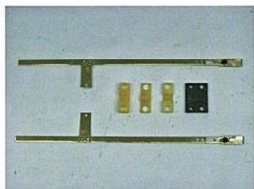

G1247



G1248



G1249



www.tahabelt.ir

@taha_textile



G1259

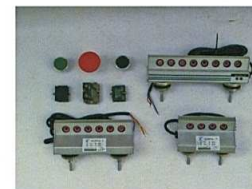

G1260

GTM/AS/GAMMA (4, 6, 8R)

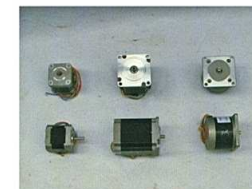

G1261

GAMMA



G1250

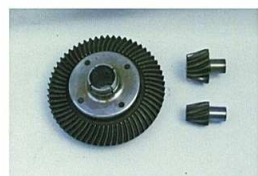

G1251

(1: 6, 1: 4)



G1252

1585



G1262



G1263

HK505812, HK505818, F29526801, F18374506, 10758, NATD22C.....



G1264

BAHB636035, 3306B, HK28/20: 32010X 210E 2207E 31307 30307D 22205..... CP34060



G1265
GTM



G1266
GTM/AS



G1267
GTM/AS
(9 12



G1268
GTM/AS
4KW, 5.5KW



G1269
GTM/AS

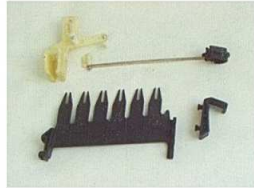

G1270
GTM/AS
GTMAS



G1271
1585, 1600



G1272

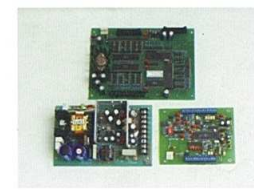

G1273
GTM/AS
GAMMA
GTMAS



G1274
PAT-A



G1275
PAT-A



G1276
PAT-A

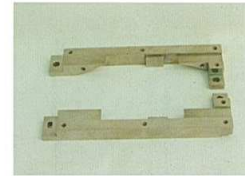

G1277
GAMMA 98

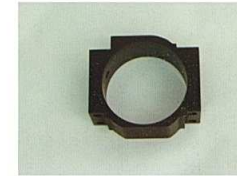

G1278
GAMMA

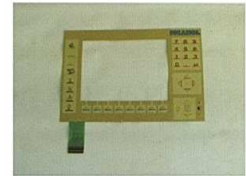

G1279
GAMMA, OMINI

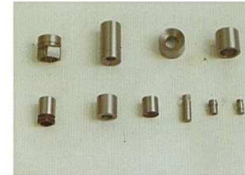

G1280

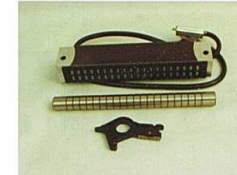

NCTM-G1281
20
20



G1282



G1283



G1284

K134.2 x 126.2 x 5.5
K78 x 70 x 8.5

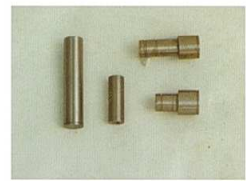

G1285



G1286



G1287



G1288

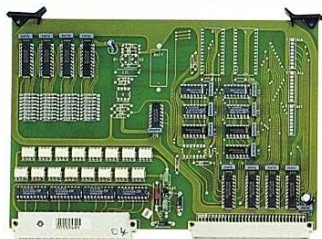

G001 BE 93608=KDRX-1
BE 91492=KDR-P1

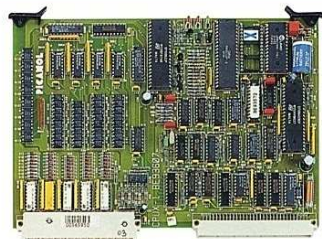

G002 BE 93607=CPUX-1



G003 BE 82869=KISG/K-2
BE 91239

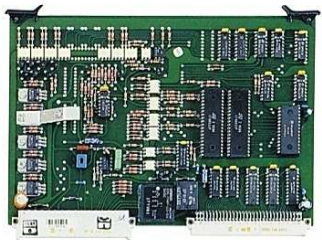

G004 BE 91239=KISG-1
BE 91498=KISG/K-1



G005 BE 93745=TIK/ABC-2



G006 BE 82426=FPR/P-1
BE 82288=FPR/PA-1



G007 BE 91953=BOD/A-1
BE 82987

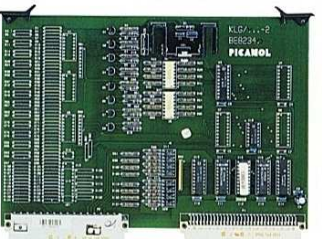

G008 BE 82340
KLG/K-2



G009



G010



G011



G012



G013



G014



G015



G016



G017



G021



G022



G023



G018



G019



G020



G024



G025



G026



G027



G028



G029



@taha_textile



@taha_textile



@taha_textile



@taha_textile



@taha_textile



G066



NCTM-G087



G067



G088



G068



G069



G070



G071



G072



G073



G074



G075



G076



G077



G078



G079



G080



G081



G082



G083



G084



G085



G086



@taha_textile



G089



G090



G091



G092



G093



G094



G095



G096



G097



G098



G099



G100



G101



G102



G103



G104



G105



G106



G107



G108



@taha_textile



G109



G110



G111



G112



G113



G114



G115



G116



G117



G118



G119



G120



G121



G122



G123



G124



G125



G126



G127



G128



G129



G129



G129



G129



G130



G132



G131



G133



G134



G135



G136



G137



G138



G139



G140



G141



G142



G143



G144



G145



G146



G147



G148



G149



G150



G151



G153



G152



G154



G155



G156



G157



G158



G159



G160



G161



G162



G163



G164



G165



G166



G167



G168



G169



G170



G171



G172



G173



G174



G175



G176



G177



G178



G179



G180



G181



G182



G183



G184



G185



G186



G187



G188



G189



G190



G191



G192



G193



G194



G195



G196



G197



G198



G199



G200



G204



G201



G202



G203



G205

